

EN 300 328, V2.2.2, 2019

Module Integration Test Report

Report No. CJJJ-TNY-P23060072-2_BluesWireless_NOTE_EN300328

Test Model: WBNAW, WBGLW, NBGLW, NBNWA, WBEXW

Test Date: 08/11/2023

Issued Date: 10/06/2023

Applicant: Blues, Inc.

Address: 50 Harbor St, Manchester, MA 01944

Manufacturer: Blues, Inc.

Address: 50 Harbor St, Manchester, MA 01944

Issued By: Bureau Veritas Consumer Products Services, Inc.

Lab Address: 775 Montague Expressway, Milpitas, CA 95035

Test Location (1): 775 Montague Expressway, Milpitas, CA 95035



This report is for your exclusive use. Any copying or replication of this report to or for any other person or entity, or use of our name or trademark, is permitted only with our prior written permission. This report sets forth our findings solely with respect to the test samples identified herein. The results set forth in this report are not indicative or representative of the quality or characteristics of the lot from which a test sample was taken or any similar or identical product unless specifically and expressly noted. Our report includes all of the tests requested by you and the results thereof based upon the information that you provided to us. You have 60 days from date of issuance of this report to notify us of any material error or omission caused by our negligence, provided, however, that such notice shall be in writing and shall specifically address the issue you wish to raise. A failure to raise such issue within the prescribed time shall constitute your unqualified acceptance of the completeness of this report, the tests conducted and the correctness of the report contents. Unless specifically mentioned, the uncertainty of measurement has been explicitly taken into account to declare the compliance or non-compliance to the specification. The report must not be used by the client to claim product certification, approval, or endorsement by A2LA or any government agencies.

Table of Contents

Release Control Record	3
1 Certificate of Conformity	4
2 Summary of Test Results	5
2.1 Measurement Uncertainty	6
2.2 Modification Record	6
3 General Information	7
3.1 General Description of EUT	7
3.1.1 Configuration of System under Test	8
3.2 General Description of Applied Standards	9
3.2.1 Test Instruments	10
3.2.2 Deviation from Test Standard	10
4 Radiated Transmitter Unwanted Emissions	11
4.1.1 Limits	11
4.1.2 Test conditions:	11
4.1.3 Test Setup Diagram	12
4.1.4 Test Procedure	12
4.1.5 Deviation from Test Standard	12
4.1.6 Test Setup	12
4.1.7 Test Results	13
5 Pictures of Test Arrangements	14
Appendix – Information on the Testing Laboratories	16

Release Control Record

Issue No.	Description	Date Issued
CJJJ-TNY-P23060072- 2_BluesWireless_NOTE_EN300328	Original Release	10/06/2023

1 Certificate of Conformity

Product: NOTE

Brand: Blues, Inc.

Test Model: WBNAW, WBGLW, NBGLW, NBNAW, WBEXW

Sample Status: Engineering sample

Applicant: Blues, Inc.

Test Date: 08/11/2023

Standards: EN 300 328 V2.2.2:2019

The above equipment has been tested by **Bureau Veritas Consumer Products Services, Inc., Milpitas Branch**, and found compliance with the requirement of the above standards. The test record, data evaluation & Equipment Under Test (EUT) configurations represented herein are true and accurate accounts of the measurements of the sample's EMC characteristics under the conditions specified in this report.

Prepared by :  _____ , **Date:** 08/11/2023
Brandon Quan / Test Engineer

Approved by :  _____ , **Date:** 08/11/2023
Suresh Kondapalli / Engineer Reviewer

2 Summary of Test Results

EN 300 328 V2.2.2 (2019-07)			
Reference Clause	Test Parameter	Result	Remarks
4.3.2.8	Transmitter unwanted emissions in the out-of-band domain	Pass	Meets the requirement
4.3.2.9	Transmitter unwanted emissions in the spurious domain	Pass	Meets the requirement

2.1 Measurement Uncertainty

Where relevant, the following measurement uncertainty levels have been estimated for tests performed on the EUT:

This uncertainty represents an expanded uncertainty expressed at approximately the 95% confidence level using a coverage factor of $k=2$.

Measurement	Frequency	Expanded Uncertainty ($k=2$) (\pm)
Conducted Emissions at mains ports	150kHz ~ 30MHz	3.51dB
Radiated Emissions up to 1 GHz	30MHz ~ 1GHz	3.73dB
Radiated Emissions above 1 GHz	1GHz ~ 6GHz	4.64dB
	6GHz ~ 18GHz	4.82dB
	18GHz ~ 40GHz	4.91dB

2.2 Modification Record

There were no modifications required for compliance.

3 General Information

3.1 General Description of EUT

Product	NOTE
Brand	Blues, Inc.
Test Model	WBNAW (worst-case)
Certified Module	Quectel EG-91 LTE Module
Status of EUT	Engineering sample
Power Supply Rating	2.5VDC to 5.5VDC

3.1.1 Configuration of System under Test

The EUT has been tested as an independent unit together with other necessary accessories or support units. The following support units or accessories were used to form a representative test configuration during the tests.

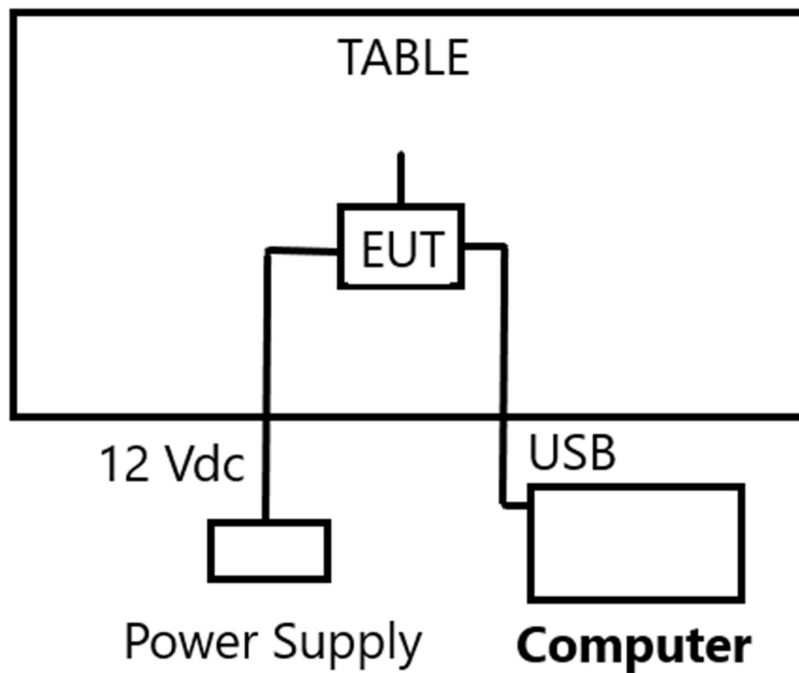

3.2 General Description of Applied Standards

The EUT is a RF Product. According to the specifications of the manufacturer, it must comply with the requirements of the following standards:

ETSI EN 300 328 V2.2.2 (2019-07)

All test items have been performed and recorded as per the above standards.

3.2.1 Test Instruments

DESCRIPTION & MANUFACTURER	MODEL NO.	SERIAL NO.	DATE OF CALIBRATION	DUE DATE OF CALIBRATION
EMI Receiver Rohde and Schwarz	ESW44	1328.4100K- 101662-MH	09/20/2022	09/20/2023
Biconilog Antenna Sunol	JB6	A111717	09/22/2022	09/22/2023
Test Software Toyo Corporation	EP7/RE	V.8.0.130	-	-

3.2.2 Deviation from Test Standard

No deviation

4 RADIATED TRANSMITTER UNWANTED EMISSIONS

4.1.1 Limits

Reference: clause 4.3.2.9 Table 4 of ETSI EN 300 328

The spurious emissions of the receiver shall not exceed the values given in table below.

For emissions radiated by the cabinet or emissions radiated by integral antenna equipment (without antenna connectors), these limits are e.r.p. for emissions up to 1 GHz and e.i.r.p. for emissions above 1 GHz.

Transmitter limits for spurious emissions

Frequency Range	Maximum Power Limit	Bandwidth
30 MHz to 47 MHz	-36dBm	100kHz
47 MHz to 74 MHz	-54dBm	100kHz
74 MHz to 87,5 MHz	-36dBm	100kHz
87,5 MHz to 118 MHz	-54dBm	100kHz
118 MHz to 174 MHz	-36dBm	100kHz
174 MHz to 230 MHz	-54dBm	100kHz
230 MHz to 470 MHz	-36dBm	100kHz
470 MHz to 862 MHz	-54dBm	100kHz
862 MHz to 1 GHz	-36dBm	100kHz
1GHz ~ 12.75GHz	-30dBm	1MHz

4.1.2 Test conditions:

Normal condition according to section 3.3.1 of this report. The EUT was set to transmit in the lowest and highest channel for testing.

4.1.3 Test Setup Diagram

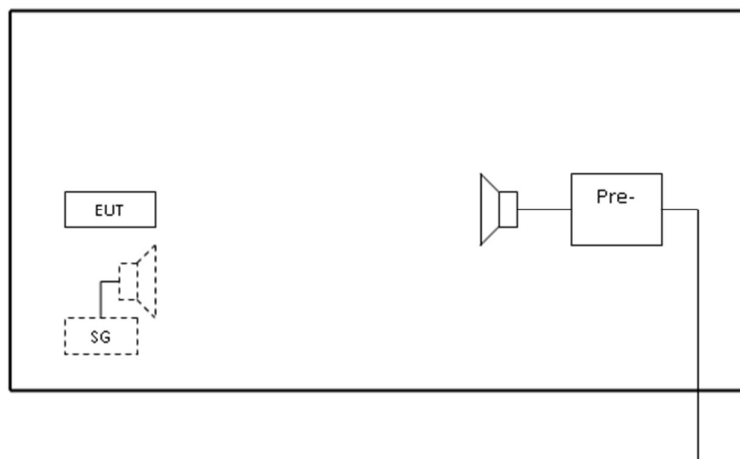

4.1.4 Test Procedure

Refer to chapter 5.4.9 of EN 300 328 V2.2.2 (2019-07).

Measurement Method	
<input type="checkbox"/> Conducted measurement	<input checked="" type="checkbox"/> Radiated measurement
<p><u>For Conducted measurement:</u></p> <p>The level of unwanted emissions shall be measured as their power in a specified load (conducted spurious emissions) and their effective radiated power when radiated by the cabinet or structure of the equipment with the antenna connector(s) terminated by a specified load (cabinet radiation).</p>	
<p><u>Conducted measurement (For equipment with multiple transmit chains):</u></p> <p><input type="checkbox"/> Option 1: The results for each of the transmit chains for the corresponding 1MHz segments shall be added and compared with the limits.</p> <p><input type="checkbox"/> Option 2: The results for each of the transmit chains shall be individually compared with the limits after these limits have been reduced by $10 \times \log(N)$ (number of active transmit chains)</p>	

4.1.5 Deviation from Test Standard

No Deviation.

4.1.6 Test Setup

1. For the actual test configuration, please refer to the related Item in this test report (Photographs of the Test Configuration).
2. The equipment was configured to operate under its worst case situation with respect to output power.
3. The test setup has been constructed as the normal use condition. TeraTerm has been activated to set the EUT on specific status.

4.1.7 Test Results

Wifi

30MHz-1GHz

Freq. MHz	Raw dBuV	Corrd' dB	Level dBuV	Meas Type	Ant Pol	Ant Hgt cm	TT Azt Deg	QP Limit dBuV	QP Margin dB
59.405	45	-6.9	38.1	QP	V	150	175	43.4	5.3
79.881	49.9	-7.4	42.5	QP	H	211	178	43.4	0.9
312.002	44.8	-4.2	40.6	QP	H	132	203	43.4	2.8
531.438	21.1	-2	19.1	QP	H	157	195	43.4	24.3
647.355	21.4	-0.4	21	QP	H	150	186	43.4	22.4
712.41	20.9	-0.1	20.8	QP	H	173	177	43.4	22.6

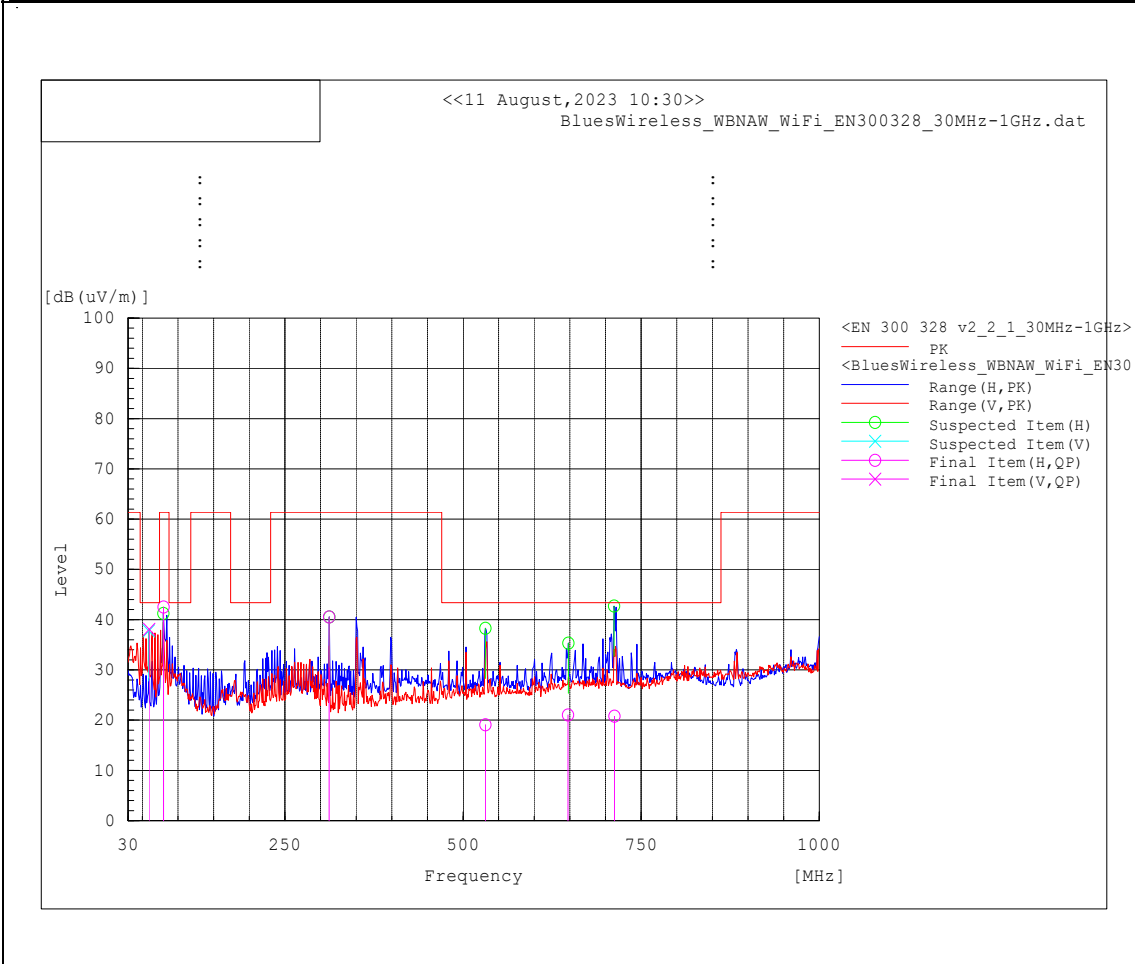

5 Pictures of Test Arrangements

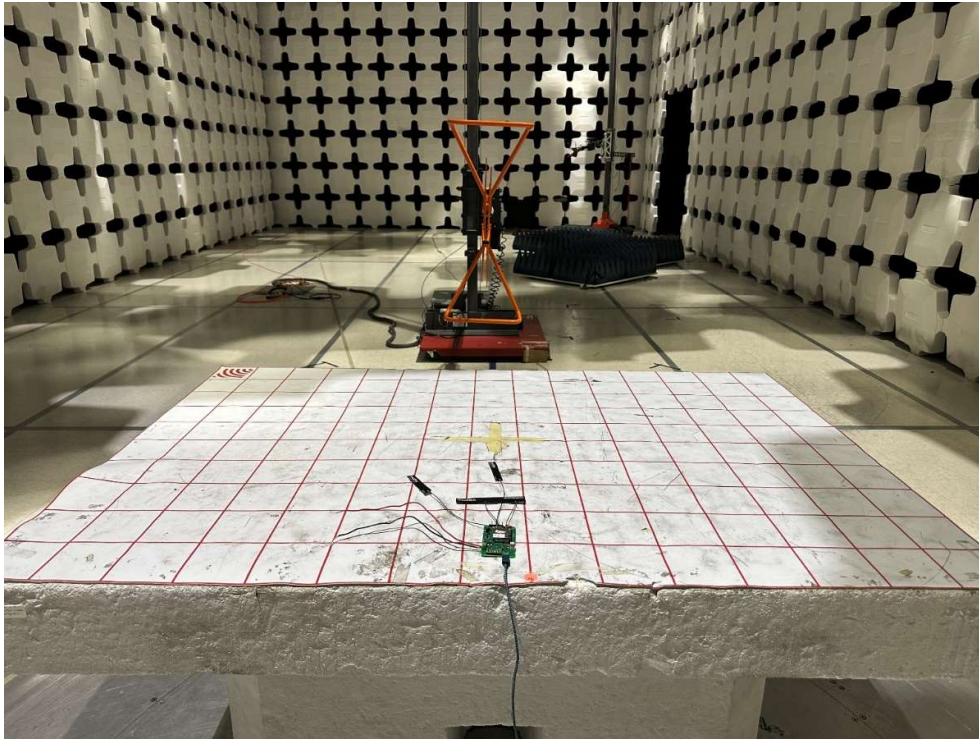

30 to 1000 MHz Radiated Emissions Test Setup – Front

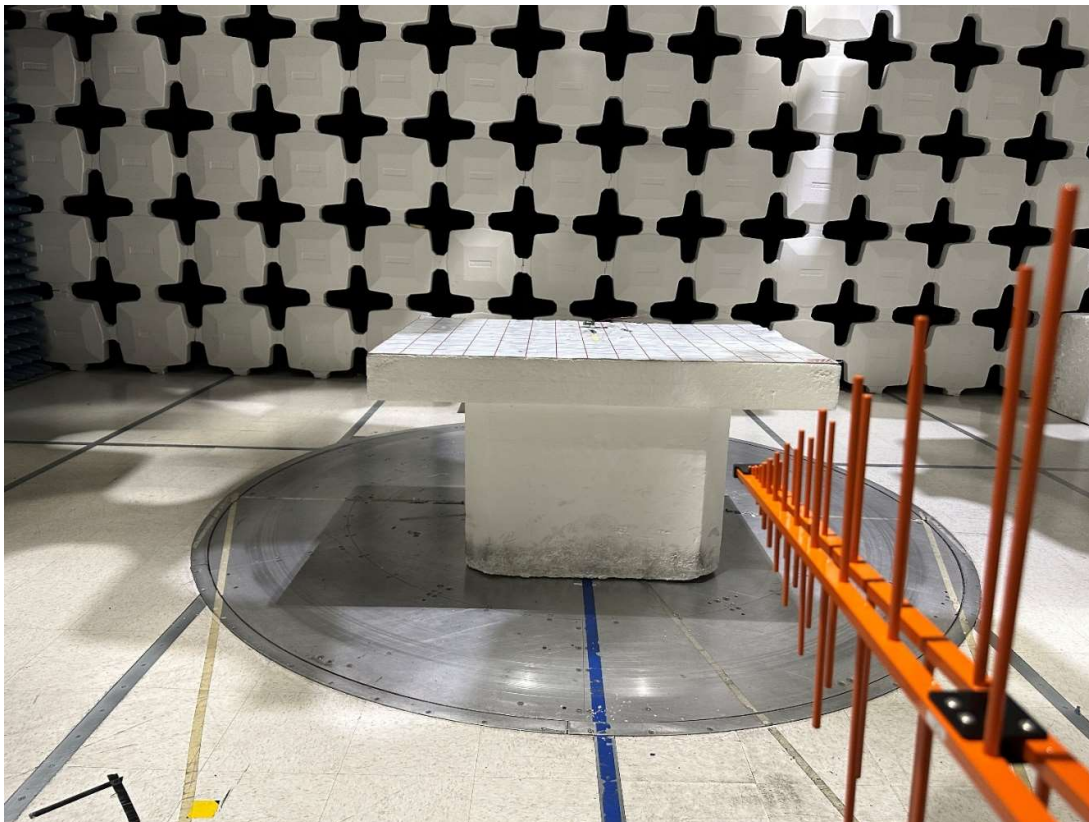

30 to 1000 MHz Radiated Emissions Test Setup – Rear

Appendix – Information on the Testing Laboratories

Bureau Veritas is a global leader in testing, inspection and certification (TIC) services. We help businesses improve safety, sustainability and productivity; and our clients include the majority of leading brands in retail, manufacturing and other industries. With a presence in every major country around the world, our quality assurance and compliance solutions are vital in helping our customers enhance product quality and concept-to-consumer journeys. We also assist with increasing speed to market, profitability and brand equity throughout the supply chain. Bureau Veritas is a leading wireless/IoT testing, inspection, audit and certification provider, with a global network of test laboratories to support the IoT industry in areas of connectivity, security, interoperability as well as quality, health & safety, and environmental/chemical requirements.

If you have any comments, please feel free to contact us at the following:

Milpitas EMC/RF/Safety/Telecom Lab

775 Montague Expressway, Milpitas, CA 95035
Tel: +1 408 526 1188

Sunnyvale OTA/Bluetooth Lab

1293 Anvilwood Avenue, Sunnyvale, CA 94089
Tel: +1 669 600 5293

Littleton EMC/RF/Safety/Environmental Lab

1 Distribution Center Cir #1, Littleton, MA 01460
Tel: +1 978 486 8880

Email: sales.eaw@us.bureauveritas.com

Web Site: www.cpsusa-bureauveritas.com

The address and road map of all our labs can be found in our web site also.

--- END ---